

分電盤

標準タイプ

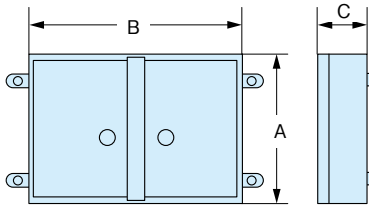

型式	Y32×3
A (mm)	560
B (mm)	605
C (mm)	215

Y32×3

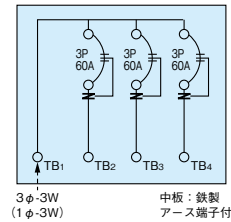

足付大型タイプ

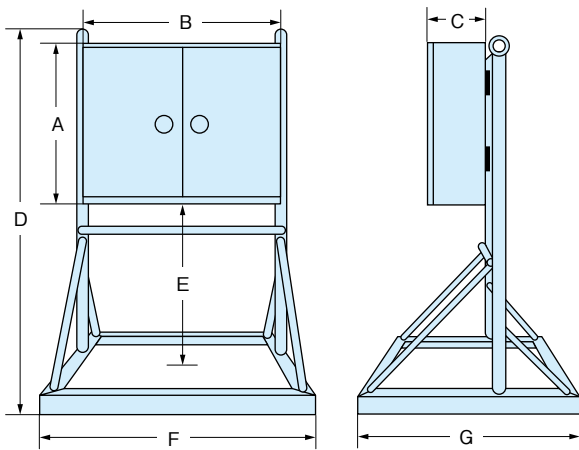

型式	Y150×4	Y175×3	Y150×4-60×2	Y300×2-150×2-60×2
A (mm)	720	720	720	955
B (mm)	910	910	900	1,200
C (mm)	260	210	200	250
D (mm)	1,550	1,510	1,600	1,600
E (mm)	830	800	880	645
F (mm)	1,060	1,080	1,050	1,300
G (mm)	950	1,000	900	900

Y150×4

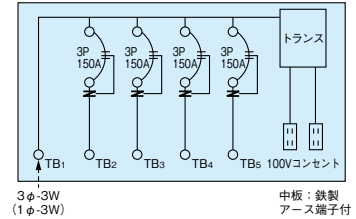

Y175×3

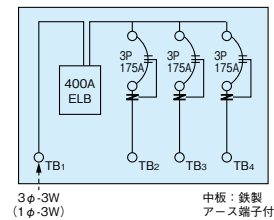

Y150×4-60×2

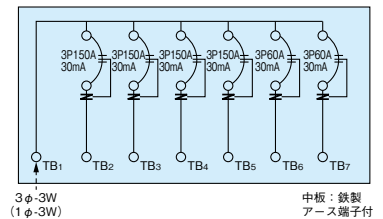

Y300×2-150×2-60×2

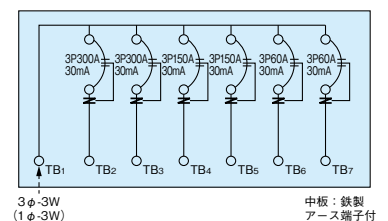

キャブタイヤケーブル (3.5～100スクア)

太さの目安

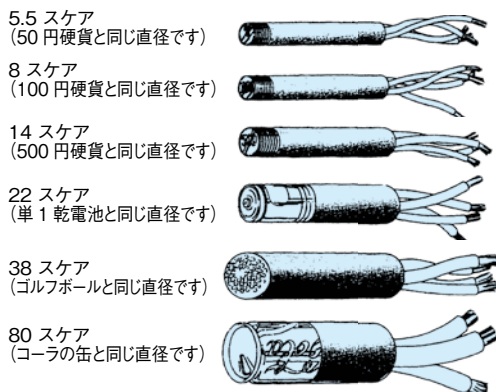

馬力 (HP)	出力 (kw)	全負荷電流 (A)	サーマルリレー定格 (A)	遮断器定格 (A)	巨長 (キャブタイヤケーブル) / キャブタイヤケーブル (スクア)													
					10	20	30	40	50	60	70	80	90	100	110	120	130	140
1	0.75	3.6	2.9~4.3	10	0.75	0.75	0.75	0.75	1.25	1.25	2.0	2.0	2.0	2.0	2.0	3.5	3.5	3.5
2	1.5	6.6	5.4~8.0	15	1.25	1.25	1.25	2.0	2.0	3.5	3.5	3.5	3.5	5.5	5.5	5.5	5.5	5.5
3	2.2	9.2	7~11	30	2.0	2.0	2.0	3.5	3.5	5.5	5.5	5.5	5.5	8	8	8	8	8
5	3.7	15	12~18	40	3.5	3.5	3.5	5.5	5.5	8	8	8	8	14	14	14	14	14
7.5	5.5	22	18~26	50	5.5	5.5	5.5	8	8	14	14	14	14	22	22	22	22	22
10	7.5	29	24~36	60	8	8	8	8	14	14	14	14	22	22	22	22	30	30
15	11	42	34~50	75	14	14	14	14	22	22	22	30	30	30	38	38	50	50
20	15	56	45~67	100	22	22	22	22	22	30	30	38	38	38	38	50	50	50
25	18.5	68	54~80	125	30	30	30	30	30	30	30	38	50	50	50	60	60	60
30	22	80	65~95	150	38	38	38	38	38	38	38	50	50	60	60	80	80	80
50	37	134	105~155	225	60	60	60	60	60	60	60	80	80	100	100	125	125	125

(注: 電動機の上記数値は、全て4極仕様です。)